

Fiber Encapsulation Additive Manufacturing: Materials for Electrical Junction Fabrication

B. Xia, M. Saari, B. Cox, E. Richer, P. S. Krueger, and A. L. Cohen*

Laboratory for Additive Manufacturing, Robotics, and Automation (LAMRA), Department of
Mechanical Engineering, Bobby B. Lyle School of Engineering, Southern Methodist University,
Dallas, TX 75275

* Corresponding author

Abstract

Fiber Encapsulation Additive Manufacturing (FEAM) is a novel 3-D printing process that permits the printing of electromechanical and electronic devices within a single, affordable machine. A key challenge of FEAM is creating robust and reliable electrical junctions between encapsulated wires, enabling more complex devices and circuits to be fabricated. We present current efforts to explore and characterize several different methods for creating junctions: solder, solder paste, and a custom-formulated electrically conductive polymer composite. All three methods are analyzed in terms of printability, material compatibility, repeatability, and performance.

Introduction

In recent years, increasing research attention has been focused in the area of additive manufacturing (AM) of electronics and electromechanical devices [1-3]. These investigations attempt to utilize the intrinsic ability of AM to rapidly fabricate complex customized geometries, enabling designers to pursue sophisticated designs that were previously impossible. Additionally, such extensions of AM promise to achieve a higher level of functionality and performance, significant reductions in size, weight, and cost when compared to traditional manufacturing techniques.

A rapidly-growing field in robotics is soft robotics. Soft robots have several important advantages over conventional rigid robots [4]. Made from soft materials, such robots can function safely in close proximity to people, which is an advantage in co-robot systems, allowing them to work with people, and aid them in a multitude of tasks. Also soft robots can grasp and manipulate delicate irregular objects in ways that rigid robots cannot. For example, a soft robotic gripper can catch an uncooked egg without damaging the shell [5]. Additionally, soft robot parts can provide more degrees of freedom, enable more complex motion, and undergo shape transformations. These attributes can allow them to work in limited spaces, such as search and rescue operations after earthquakes. Soft robots typically have many degrees of freedom, which while enabling a large range of shapes and motions, may necessitate a large number of distributed actuators. Moreover, they may incorporate distributed sensors, for example, for proprioceptive feedback and in a tactile sensing “skin”.

Motivated by the benefits of 3-D printed electronic and electromechanical devices and by the needs of soft robots, Fiber Encapsulation Additive Manufacturing (FEAM) has been developed by researchers at the Laboratory for Additive Manufacturing, Robotics, and Automation (LAMRA) at Southern Methodist University [6]. FEAM is a novel additive manufacturing process in which a fiber and a matrix are co-deposited simultaneously within a single printer along straight or curved paths. In FEAM the fiber can be a robust, high-conductivity metal wire (assumed here) for electronic/electromechanical applications, while the matrix can be a soft material, e.g., for soft robotics and wearable electronic applications, or a hard material, as required.

To develop FEAM, three key capabilities are required: wire encapsulation and centering, starting and stopping the wire, and forming electrical junctions between wires. Significant progress has been made and already described with regard to the first two capabilities [7]. Based on earlier work, a number of devices have been produced including a loudspeaker, inductive sensors, a solenoid actuator, membrane switches, and a capacitive force sensor, as shown in Figure 1. This paper will focus on printing electrical junctions, which enable far more complex circuitry and devices.

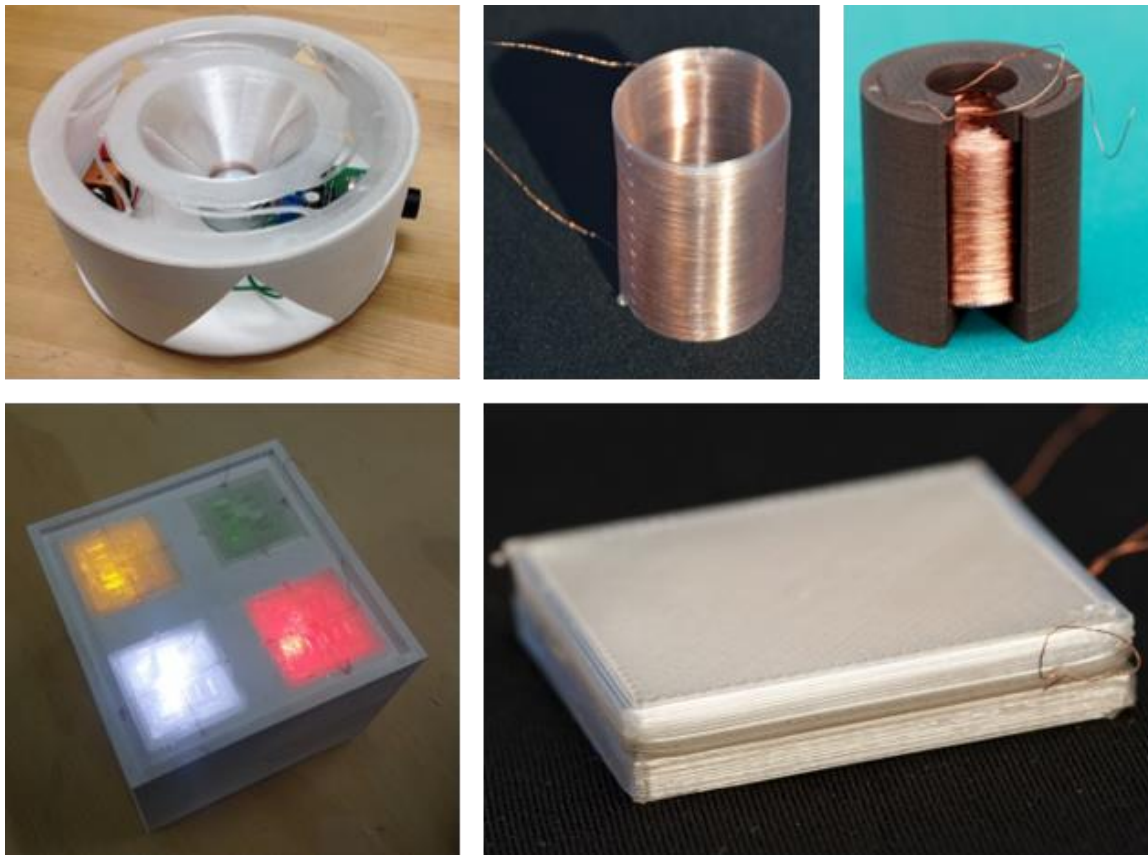

Figure 1. Devices printed using Fiber Encapsulation Additive Manufacturing.

Printing Electrical Junctions

Individual parts such as the simple coil shown in Figure 1 (top middle) or even more sophisticated coils (top right) may be printed with a single continuous length of wire. However, in context of printing all but simple circuits, multiple discrete straight or curved segments of wires will be required. Connecting discrete segments of wires in the same layer or across multiple layers thus becomes important to the FEAM process. Additionally, in order to automatically, monolithically print an entire pre-assembled system which may include electromechanical devices, actuators, sensors, interconnects, processors, and power sources, junctions between printed wires are required.

However, it is not trivial to engineer junctions to work within a FEAM system. To reliably fabricate an electronic or electromechanical device, junctions need to have low resistivity and high current capacity so electrical components can operate with good performance and acceptable efficiency. It is also important that the junction be robust and durable, especially if complex motion or shape transformation of the device is part of the design objective. The material to fabricate the junctions needs to have good printability and compatibility with the surrounding material. Repeatability must also be considered to guarantee the quality of the fabricated system. Moreover, other aspects such as adhesion of the junction material to wire, cost, and printing time need to be included in the choices for electrical junction fabrication.

The wires or the wire and electrical elements to be connected may lie in the same layer or in adjacent layers. In an effort to model these kinds of printing conditions, junctions of two types of structures are tested and discussed in this paper. An intra-layer junction is one in which two or more wires lie in the same layer as shown in Figure 2 (a). An inter-layer junction is where wires lie in neighboring layers shown as Figure 2 (b).

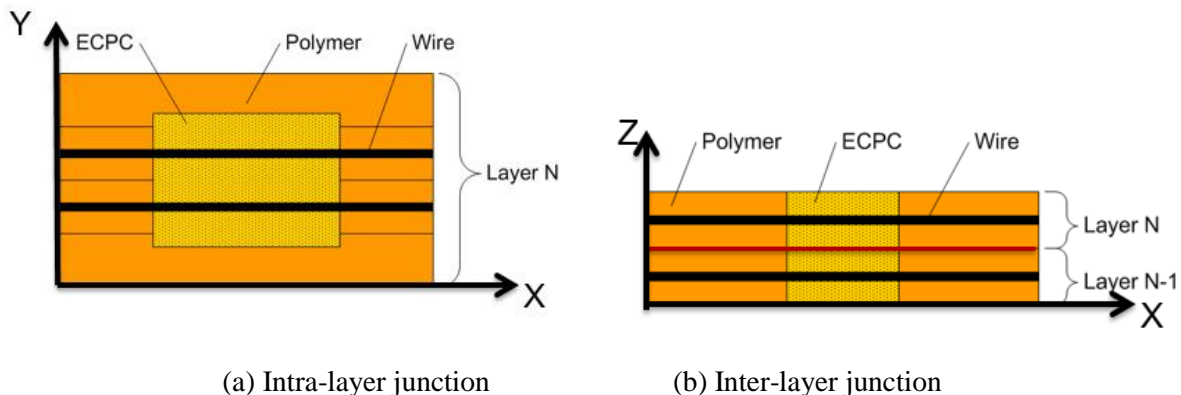

Figure 2. Schematic junctions.

To satisfy the performance requirements for junctions, various materials have been investigated. Three following candidate materials and their printing methods are explored: electrically conductive polymer composite (ECPC), solder, and solder paste.

Electrically Conductive Polymer Composite

A variety of custom ECPC materials have been explored by our group [8]. They consist of an electrically conductive metal powder and a polymer matrix. Polymers in ECPC are intended to bind metal powder and enable material extrusion. The metal powder chosen was silver-coated nickel. Three types of polymers were tested for ECPC formulation including Kraton D1161 P (Kraton Performance Polymers Inc. Houston, TX), Crystalbond 555 (Aremco Products Inc., Valley Cottage, NY), and beeswax.

Among the various materials explored, beeswax was unable to bind to the metal powder sufficiently well in order to achieve sufficient blending, as seen in Figure 3. The ECPC it produces was very fragile, and did not meet the mechanical strength requirements for the FEAM process.



Figure 3. ECPC made of beeswax and silver coated nickel powder.

Crystalbond 555 was more readily blended with the metal powder at the same volume fraction as the Kraton D1161 P. The resulting ECPC was fabricated quickly (within five minutes) by blending the components at elevated temperature, even when the volume fraction of metal powder approached 35%. In comparison, ECPC produced with Kraton D1161 P, a thermoplastic elastomer, could only be mixed to a volume fraction of metal powder as large as 29% while simultaneously maintaining printability. Additionally, Kraton D1161 P ECPC took around two hours to formulate the same volume as that made with Crystalbond 555. Crystalbond 555 however had some difficulty binding to the metal powder. The resulting resistivity of the ECPC made from this kind of polymer was almost ten times higher than the ECPC made from Kraton D1161 P with the same volume fraction of metal powder, as shown in Table 1. The ECPC made of Crystalbond 555 was less readily extruded than that made of Kraton D1161 P as well. Comparing the two types of material,

it can be concluded that the ECPC made of Kraton D1161 P has better abilities to fabricate ECPC-based junctions in the FEAM system than that made of Crystalbond 555. Thus, only Kraton D1161 P is investigated further here.

Volume Fraction	23%	25%	27%	29%	30%	33%	35%
Crystalbond 555 (Ω -cm)	nonconductive	0.571	0.568	0.560	0.558	0.551	0.547
Kraton D1161 P (Ω -cm)	0.148	0.038	0.026	0.019	cannot be fabricated		

Table 1. Resistivity of ECPC made from TPE D1161P and Crystalbond 555 vs. volume fraction of metal powder.

Since metal powder is providing the electrical conductivity in ECPC, it is expected that increasing the volume fraction of metal powder will result in the resistivity decreasing somewhat. This was observed experimentally, as shown in Table 1 and Figure 4. The reason for the rapid decrease at the beginning and the slower decrease of resistivity at higher powder volume fraction is supported by the fact that once electrical percolation has been achieved, relatively small decreases in resistivity are expected as more powder is added. When the volume fraction of metal powder is large enough, approximately 25%, the powder in ECPC has sufficient metal particulate to permit percolation allowing current to flow. After that point, the slower decreasing rate of resistivity is limited by the binder capacity and the resistivity of the metal powder.

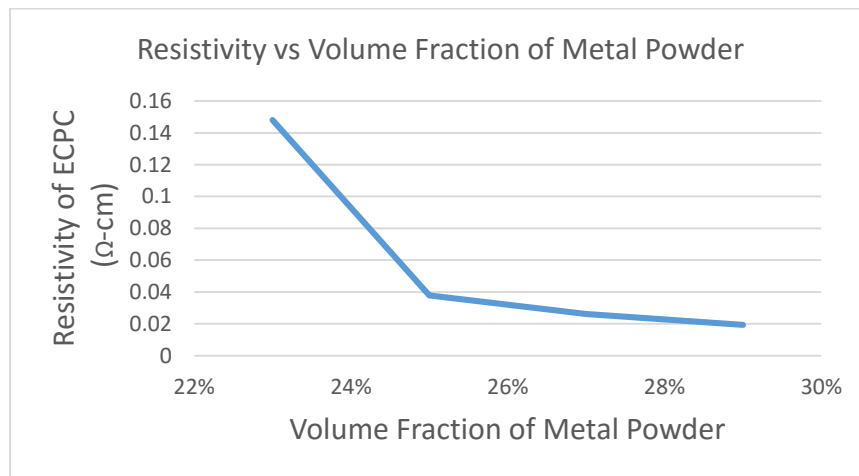

Figure 4. Resistivity vs Volume Fraction of Metal Powder.

Concurrently, since printability (via material extrusion) is determined in part by material rheology, it is expected that printability will behave in the opposite fashion to conductivity with respect to increasing volume fraction of metal powder. Indeed, it was found that printability decreases dramatically as volume fraction of metal powder increases. When the volume fraction becomes 30%, the ECPC formulation has a rough surface texture, is friable, and can no longer be printed through a small nozzle, as shown in Figure 5. So by balancing these two opposing properties, the

optimal volume fraction of silver-coated nickel powder in Kraton D1161 P ECPC used to print electrical junctions was approximately 29%.



(a) 29% metal powder. (b) 30% metal powder.

Figure 5. ECPC filament made of Kraton D1161P with 29% and 30% metal powder.

Under constant tensile load applied to ECPC filament, it was observed that resistivity decreased with time, as shown in Figure 6. When a constant load is applied to the filament, strain will be generated. The strain will increase rapidly at first and slow down when approaching the strain relaxation limit. During increased strain relaxation, resistivity decreased. We hypothesize that as the filament elongates, the metal powder particles in the ECPC filament become pressed more closely together, increasing the number and area of conductive paths between particles. However, it was not possible to determine relationship between strain and resistivity from the present results

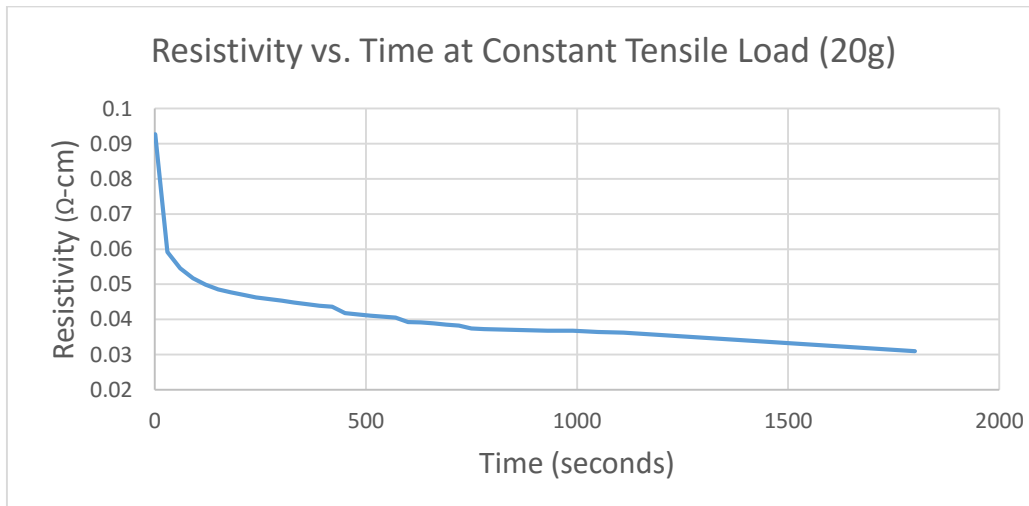
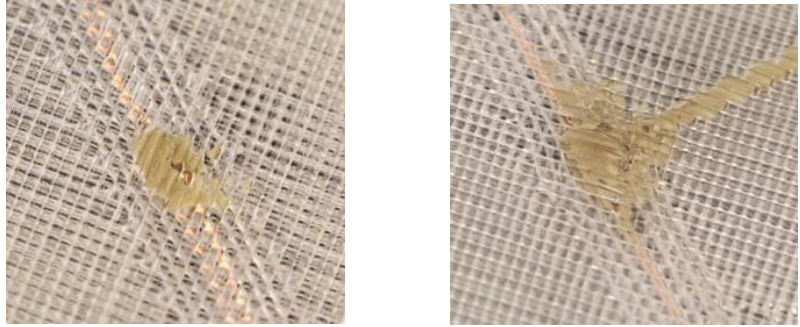

Figure 6. Time dependent effects of constant loading on resistivity of an ECPC filament comprising Kraton D1161.

In addition, the experimental results show that intra-layer and inter-layer ECPC-based junctions require a very short time to be printed. 3 seconds is enough time to deposit an inter-layer or intra-layer junction; however, printing time varies with the geometry of the parts. The typical resistances of these two kinds of junctions are 250 mΩ and 110 mΩ, respectively. The difference in resistance is attributed partly to the distance between wires (~250 μm center-center for inter-layer junctions, vs. ~450 μm for intra-layer junctions) while the relative high resistance of the junctions is likely caused by poor wire adhesion to ECPC and/or voids in the ECPC.



(a) Intra-layer junction.

(b) Inter-layer junction.

Figure. 7. ECPC junctions.

The Kraton D1161 P-based ECPC was printed using the Thermoplastic Elastomer Additive Manufacturing (TEAM) system developed at LAMRA [8]. The TEAM system consists of a constant pitch miniaturized screw extruder, inspired by industrial screw extruders, mounted as a material extrusion extruder on a 3-D printer. Other research [9] has shown this system able to 3-D print a wide variety of TPEs including Kraton D1161 P.

The TEAM extruder design is shown in Figure 8. ECPC pellets were fed into the extruder through a pellet hopper, and are transported through the barrel to the extruder by the screw rotated by a geared stepper motor. The hot-end block and barrel are heated by a cartridge heater and band heater, combined with a heat sink to produce the desired temperature gradient to drive flow. The ECPC was extruded out of the nozzle into prefabricated junction cavities (in which the wires were embedded in non-conductive material printed with FEAM), producing conductive junctions.

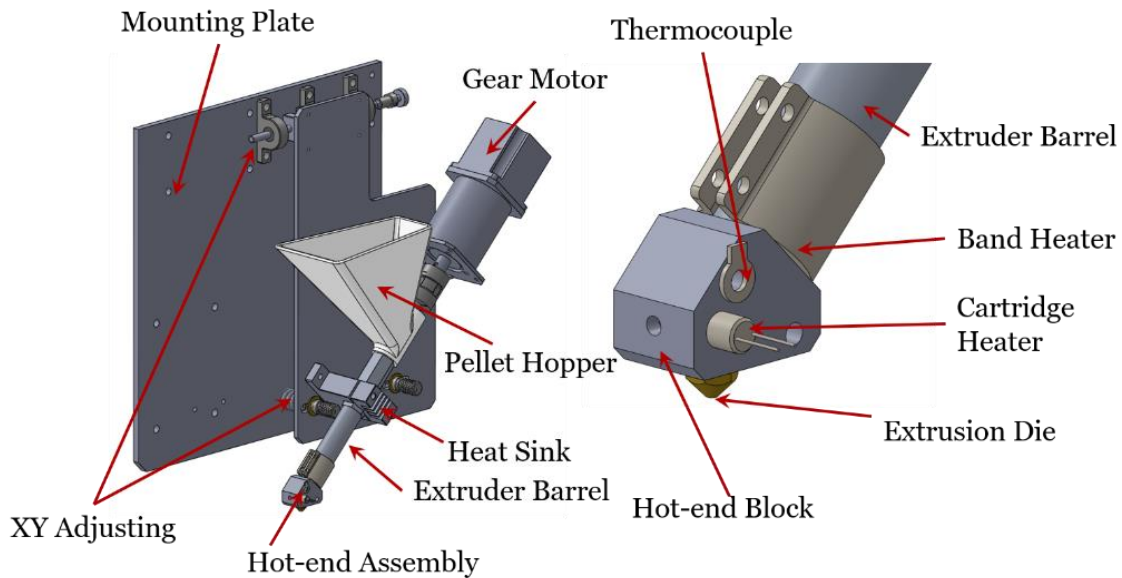

Figure 8. TEAM miniature screw extruder schematic.

On a volumetric basis, the materials used in ECPC junctions have the lowest price among all three type of junctions compared in this paper, but other junctions may use less material. The material melting point of ECPC is relatively low, and ECPC junctions can be printed with reasonable repeatability if the junction is well designed. The relatively short time required to print an ECPC junction makes the process very efficient when utilized for printing an entire electronic/electromechanical system. Thus even though ECPC junctions are considerably less conductive than others we have investigated, they remain an attractive option.

Solder-based Junctions

Solder is a very common material used to fabricate electrical junctions. Several experiments have been conducted by multiple groups, such as printing solder with material extrusion systems [10], and directly printing solder to build circuit board surface traces [11]. It is clear that, at low cost, solder can fabricate electrical junctions that have very low resistance, and are robust and have good mechanical strength.

However, other aspects such as printability and material compatibility need to be investigated to decide whether solder is a good fit for fabricating electrical junctions in combination with FEAM. To test solder junctions, two printing methods were investigated: molten solder extrusion and forced convection melting.

Molten solder extrusion is a method explored for printing junctions with a syringe extruder as seen in Figure 9. The solder is put into the syringe, a wraparound heater heats the solder to above its melting point, and then the solder is injected through a heated needle onto the wires to form the junction.



Figure 9. Molten solder extrusion.

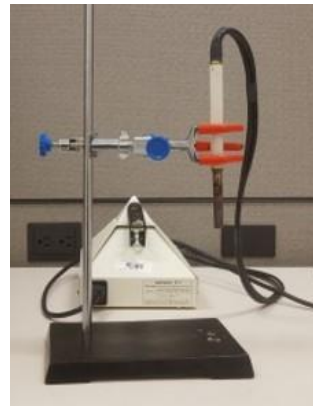

Figure 10. Forced convection melting.

Forced convection melting is a similar method; but in this case, hot air is convected to the solder by a ZT-2-MIL hot air pencil (Zephyrtronics, Pomona, CA) as shown in Figure 10. After the hot air pencil is preheated to the solder's melting point, hot air is aimed at solid wire solder beneath it. The melted solder detaches and drops onto the wires to form the junction.

	In52/Sn48	58Bi/42Sn	97In/3Ag
Melting point (°C)	118	138	143
Minimum solder ball dia obtained (mm)	0.83	0.99	0.93
Resistance of fabricated junctions (mΩ)	6.9	7.1	6.8

Table 2. Solder used to fabricate electrical junctions.

For each of these printing methods, three types of solder were tested, and the resulting data is listed in Table 2. From experiments, it can be concluded that because of the relatively large surface tension of the melted solder, achieving a solder ball small enough to avoid damage to the surrounding (thermoplastic) polymer is difficult.

In forced convection melting, the accuracy of the final solder position is very poor due to the bulk motion of the hot air dispersing the solder. Thus, even though solder-based junctions have very low resistance, are robust and durable, print quickly and are cost-effective, such junctions do not easily meet the requirements to fabricate electrical junctions as part of a FEAM system.

Solder Paste Deposition and Reflow Junctions

Compared with solder, solder paste is another common material used to fabricate electrical junctions. As with solder, low electrical resistance, robust and durable mechanical strength can be achieved. However, solder paste consists of very small solder balls immersed in a liquid solder flux and needs to be dispensed. A pneumatic dispenser can be used to controllably dispense solder paste onto wires as the first step in forming a junction.

To control the amount of the solder paste used for fabricating a junction, a dispenser controller (DS-982, Taiwan Tech & Material, Taiwan) was utilized. The amount of solder paste injected out of the syringe is a function of the air pressure, needle size, and dispensing time. Since needle size affects the pressure gradient in the solder paste required to drive the flow, and the position of the solder paste relative to the wires, this is the first parameter considered. Needles with IDs from 0.2 mm to 0.8 mm were tested. When needle size increased, dispensing time decreased as expected, but the accuracy of the dispensed solder paste's position decreased. If the needle was too large, solder paste would flow under hydrostatic forces. Conversely, if the needle was too small, solder paste would not be extruded with the available pressure.

To balance the effects of dispensing speed and the resulting positional accuracy, a needle of 0.33 mm ID was chosen to dispense the solder paste. To match the needle size, air pressure was set at 65 psi and the dispensing time was set to 0.5 seconds. The result was a roughly spherical solder paste ball of around 0.45 mm diameter deposited onto the wires. Using this dispensing method, three reflow methods were tested independently: soldering iron, hot air pencil, and laser. Soldering irons are common and inexpensive tools used for soldering. Since the reflowing apparatus must be integrated into the FEAM printer, and it may need to form a large number of junctions within a single device without stopping, it is of vital importance to keep the soldering tips clean after contact with the solder paste. To study this requirement, an assortment soldering tips made of PTFE and polished aluminum, and having different shapes and sizes as shown in Figure 11 were tested.

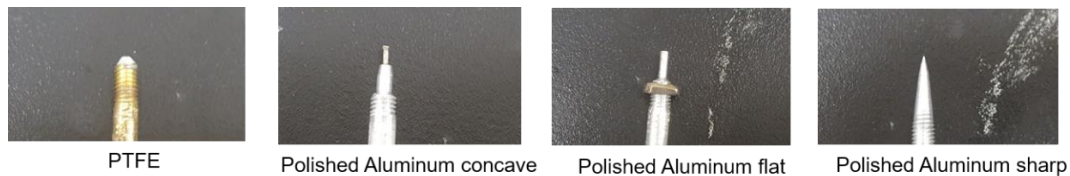

Figure 11. Custom-made soldering tips.

Good results producing intra-layer junctions were attained when heating the solder paste for two seconds, however, the tips still damaged the surrounding material. Additionally, inter-layer junctions could not be fabricated in a straightforward manner with this method: nearly 50% of inter-layer junctions could not be formed during experiments, and in the case of successful inter-layer junctions (those having low resistance and good mechanical integrity), the surrounding material was irreparably damaged. Therefore, this approach was not considered practical.



Figure 12. Solder paste-based junction reflowed by soldering iron.

Hot air sources may be used to reflow solder paste. To evaluate this approach a hot air pencil reflow system was constructed, comprising a computer-controlled X/Y positioning stage as shown in Figure 13.

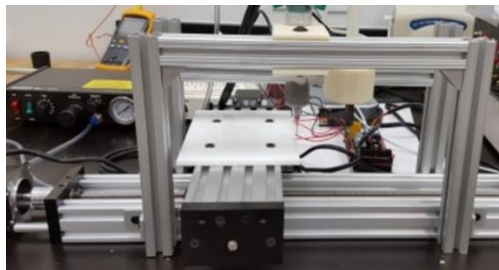
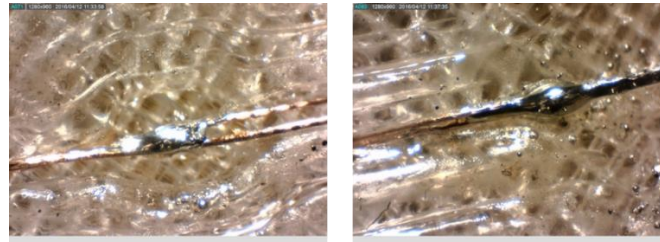

Figure 13. Hot air reflow system.

With this method, the temperature of the hot air was set to the melting point of the solder paste. The main parameter varied was the size of the air pencil nozzle. If the nozzle was too small, the mean flow velocity would be too large, and the solder paste dispensed on the wires could be easily displaced by the air jet. If the nozzle was too large, the surrounding 3-D printed material would be damaged by the hot air because it had a lower melting point than the solder paste. To balance the two effects, nozzles with an ID range from 1 mm to 5 mm were tested. The best results were obtained with a 2-mm nozzle and a reflow time of 5 seconds, as shown in Figure 14. Even though the surrounding material is barely damaged, there is some residue inside the cavity. Nonetheless, the results show that it can meet the requirements to fabricate electrical junctions as part of FEAM.



(a) Intra-layer junction. (b) Inter-layer junction.

Figure 14. Solder paste-based junction reflowed by hot air (intra-layer and inter-layer).

Laser induced thermal reflow is a less common method to reflow solder paste. The laser reflow system constructed for the investigation, shown in Figure 15, uses a computer-controlled X/Y positioning stage to control the position of the laser focal point. The laser system used included a multimode pigtail diode laser (Innolume GmbH, Dortmund, Germany), with a laser driver and mount (Arroyo Instruments LLC, San Luis Obispo, CA), and fiber collimator and lens (Thorlabs, Inc., Newton, NJ).

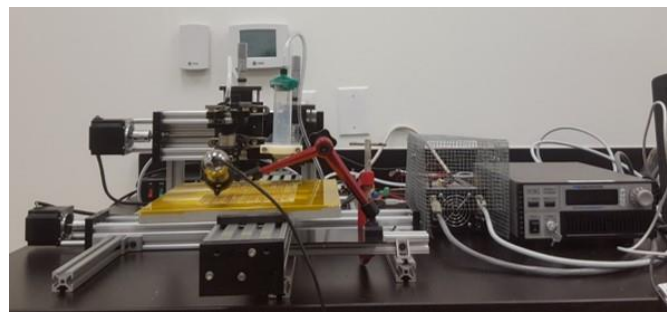
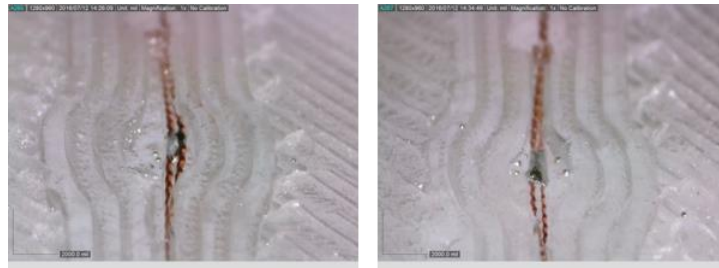

Figure 15. Automated laser solder reflow system.

The solder paste dispensed on the wires is subsequently heated by the focused laser beam. Heating time and laser current are the two primary variables which affect the quality of the junction. When the current was made too large, heating was too intense and rapid and caused spattering of the solder. If it was made too small, the heating time was extended. A current setting of 5 A with heating time of 2 seconds resulted in the junctions of the best quality for both intra-layer and inter-layer junctions, as shown in Figure 16. There is no observed difference in junction quality between inter-layer and intra-layer junctions when printing solder paste-based, laser-reflowed junctions, as the solder paste will directly form a solder ball around the two wires. However, even though the

processing time is only two seconds for the laser reflow, dispensing solder paste and subsequently moving the junction under the laser significantly can increase the total printing time parts with many junctions.



(a) Intra-layer junction. (b) Inter-layer junction.

Figure 16. Solder paste-based junction reflowed by laser (intra-layer and inter-layer).

After comparing all three methods of solder paste reflow methods, laser reflow has overall the best characteristics for obtaining electrical junctions in use with FEAM. Even though minor residue inside the cavity remains and device costs are relatively high, laser reflow still outperforms the other methods tested to date. Hot air reflow can also produce acceptable junctions for FEAM. Lastly, soldering iron reflow does not appear to be viable.

Three types of solder paste have been tested and all produce acceptable electrical junctions using the methods above. However, since laser reflow can produce junctions of the best quality as discussed above, the properties of several solder pastes were compared by using this reflowing method, as shown in Table 3. As shown, overall 96.5Sn/3Ag/0.5Cu (Version B) is the preferred solder paste based on experimental results.

	58Bi/42Sn	96.5Sn/3Ag/0.5Cu (Version A)	96.5Sn/3Ag/0.5Cu (Version B)
Melting point (°C)	138	217-219	217-219
Junction resistance (mΩ)	7.31	7.26	7.18
Cost (USD/cm ³)	1.25	2.58	1.75
Post-reflow cleaning	None	None	None
Junction mechanical strength	Good	Excellent	Excellent

Table 3: Comparison of junctions made with three types of solder paste and laser reflow.

Comparison of the Three Materials and Summary

For all three types of materials discussed and their corresponding printing methods, a detailed comparison is shown in Table 4. Accordingly, it can be concluded that solder is not a good material to fabricate electrical junctions in FEAM due to its poor printability, repeatability, and process compatibility. ECPC and solder paste satisfy all the performance requirements for printing electrical junctions. Overall, solder paste may be described as the best material for fabricating electrical junctions. However, ECPC should still be considered as it can meet the requirements and has certain advantages such as faster processing.

Important		ECPC	Solder	Solder paste	
	Printability	**	*	**	
	Repeatability	**	*	***	
	Process Compatibility	***	*	***	
	Resistivity	**	***	***	
	Wire adhesion	*	***	***	
	Printing time	***	***	**	
	Unimportant	Costs	**	***	**

Key: Excellent ***
 Good **
 Fair *

Bond text: Essential
 Regular text: Desirable

Table 4. Comparison of properties of ECPC, solder and solder paste.

Acknowledgements

This paper is based on work supported by the National Science Foundation under grant no. 1317961. Research was performed at the Laboratory for Additive Manufacturing, Robotics, and Automation, Department of Mechanical Engineering, Southern Methodist University, Dallas, Texas. The authors appreciate for their assistance Todd Danner, Daniel Porter, Samantha Reeve, and Jenya Pryadkin.

Author Disclosure Statement

The authors have no financial conflicts.

References

- [1] Espalin, David, et al. "3D Printing multifunctionality: structures with electronics." *The International Journal of Advanced Manufacturing Technology* 72.5-8 (2014): 963-978. [2] Ko, Seung H., et al. "All-inkjet-printed flexible electronics fabrication on a polymer substrate by low-temperature high-resolution selective laser sintering of metal nanoparticles." *Nanotechnology* 18.34 (2007): 345202.
- [3] Muth, Joseph T., et al. "Embedded 3D printing of strain sensors within highly stretchable elastomers." *Advanced Materials* 26.36 (2014): 6307-6312.
- [4] Majidi, Carmel. "Soft robotics: a perspective—current trends and prospects for the future." *Soft Robotics* 1.1 (2014): 5-11.
- [5] Ilievski, Filip, Aaron D. Mazzeo, Robert F. Shepherd, Xin Chen, and George M. Whitesides. 2011. "Soft Robotics for Chemists." *Angewandte Chemie International Edition* 50, no. 8: 1890–1895.
- [6] Saari M, Galla M, Cox B, Richer E, Krueger PS, Cohen AL, (2015). "Active Device Fabrication Using Fiber Encapsulation Additive Manufacturing," *Solid Freeform Fabrication Symposium*. 2015. Austin, TX, Austin, TX: University of Texas at Austin; 2015, 26-39.
- [7] Saari M, Cox B, Richer E, Krueger PS, Cohen AL, "Fiber Encapsulation Additive Manufacturing: An Enabling Technology for 3D Printing of Electromechanical Devices and Robotic Components", *3D Printing and Additive Manufacturing*, 2015; 2:32-39.
- [8] Clay, Collin. "Electrically Conductive Thermoplastic Elastomers in Application to Additive Manufacturing." Southern Methodist University, Thesis and Dissertations, 2014.
- [9] Saari M, Galla M, Cox B, Richer E, Krueger PS, Cohen AL, (2015). "Additive Manufacturing of Soft and Composite Parts from Thermoplastic Elastomers," *Solid Freeform Fabrication Symposium*. 2015. Austin, TX, Austin, TX: University of Texas at Austin; 2015, 949-958.
- [10] Mireles, Jorge, et al. "Development of a fused deposition modeling system for low melting temperature metal alloys." *Journal of Electronic Packaging* 135.1 (2013): 011008.
- [11] Kim, Min-Saeng, et al. "Direct metal printing of 3D electrical circuit using rapid prototyping." *International Journal of Precision Engineering and Manufacturing* 10.5 (2009): 147-150.